

Caring for you



NeuViz ACE (SP)

Inspire Your CT Value

NeuViz ACE (SP)/Y 22.08

Contact Us:



www.neusoftmedical.com/en/

 Neusoft Medical Systems

 Neusoft Medical

Neusoft Medical Systems

What is the value of a CT scanner?

A CT scan is one of the most commonly used medical imaging procedure in the world. It is used to diagnose diseases or evaluate injuries as well as to plan medical, surgical or radiation treatment. As a whole body scanning equipment, a quality CT scanner must have robust hardware, excellent clinical performance and a full range of clinical applications with an optimized workflow for standardized quality of care and heightened process efficiency. A CT scanner is more than a medical equipment it is a powerful research tool.

NeuViz ACE (SP) offers you consistent image quality, renewing the impression of a typical low-cost CT scanner that has finite application and limited technology. Tapping into the pioneering innovation of 512-slice platform, it delivers the true experience of high-end CT scanners. NeuViz ACE (SP) inspires your CT value in an intense competitive healthcare landscape by providing better outcomes at lower costs.

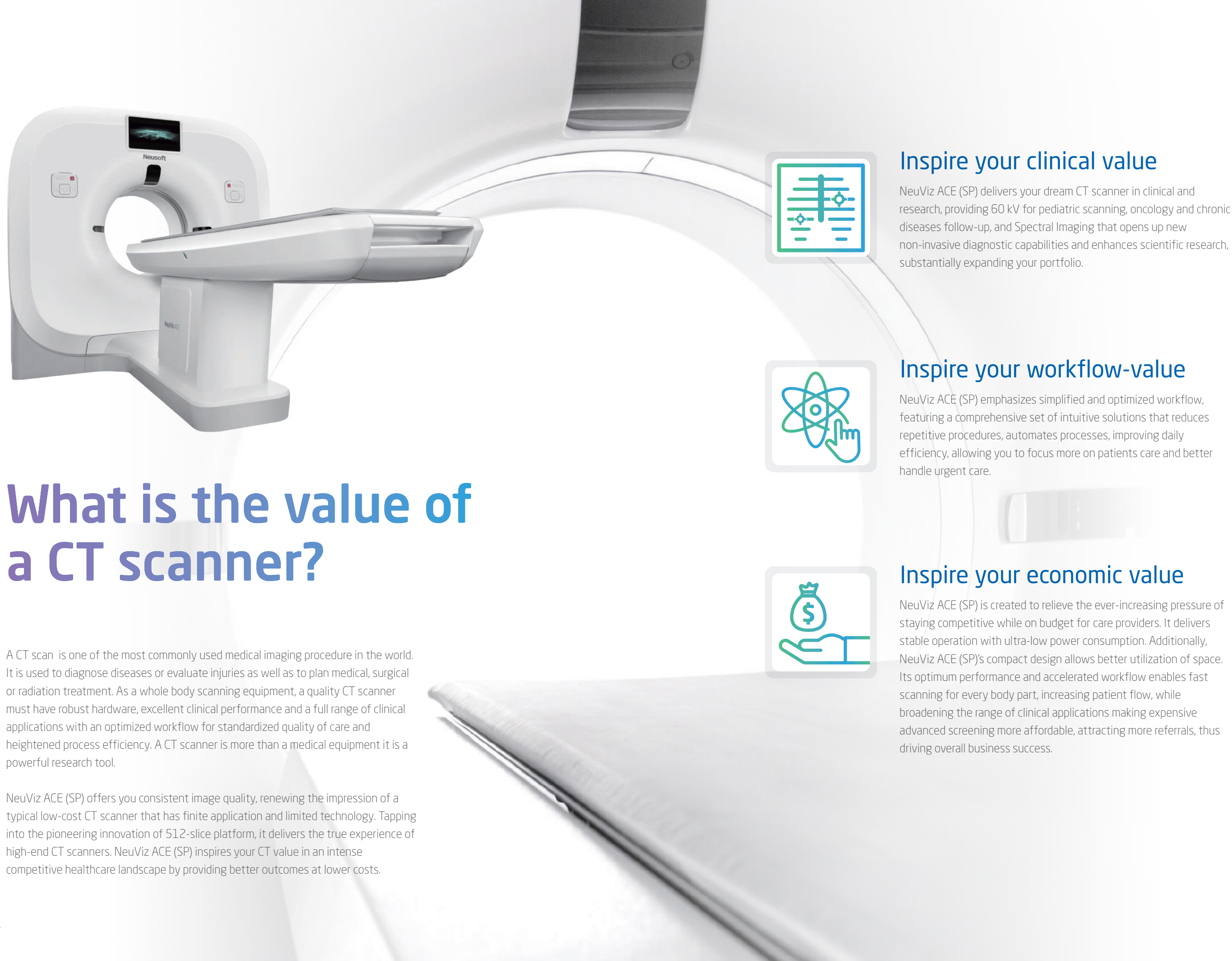

Inspire your clinical value

NeuViz ACE (SP) delivers your dream CT scanner in clinical and research, providing 60 kV for pediatric scanning, oncology and chronic diseases follow-up, and Spectral Imaging that opens up new non-invasive diagnostic capabilities and enhances scientific research, substantially expanding your portfolio.

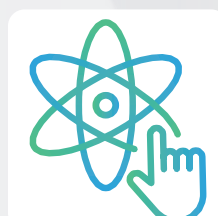

Inspire your workflow-value

NeuViz ACE (SP) emphasizes simplified and optimized workflow, featuring a comprehensive set of intuitive solutions that reduces repetitive procedures, automates processes, improving daily efficiency, allowing you to focus more on patients care and better handle urgent care.

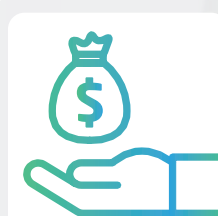

Inspire your economic value

NeuViz ACE (SP) is created to relieve the ever-increasing pressure of staying competitive while on budget for care providers. It delivers stable operation with ultra-low power consumption. Additionally, NeuViz ACE (SP)'s compact design allows better utilization of space. Its optimum performance and accelerated workflow enables fast scanning for every body part, increasing patient flow, while broadening the range of clinical applications making expensive advanced screening more affordable, attracting more referrals, thus driving overall business success.

Inspire your clinical value



CARE60

Unique 60 kV and industry leading ClearView Iterative Reconstruction Algorithm optimize dose and image quality, offering pediatric-friendly scans, making scanning safer, delivering better results and improving standard of care.



Micro120

Micro120 technology provides 120-slice reconstruction per rotation, supporting high-accuracy diagnoses and reliable treatment evaluation.



HD Imaging Chain

With performance-enhancing innovations from start to finish, NeuViz ACE (SP)'s HD imaging chain sets new standards of image quality and clinical excellence for cost-effective CT scanners.



Spectral Imaging

Spectral Imaging takes CT imaging beyond conventional imaging from anatomical assessment to quantitative tissue characterization and advanced functional imaging, reducing the need for costly invasive procedures.

Inspire your clinical value

CARE60

CARE60 is a cutting-edge collection of dose management technologies adopted directly from 512-slice CT platform. ClearView Advanced Iterative Reconstruction Algorithm facilitates noise reduction at 60 kV to actualize uncompromised low dose imaging.

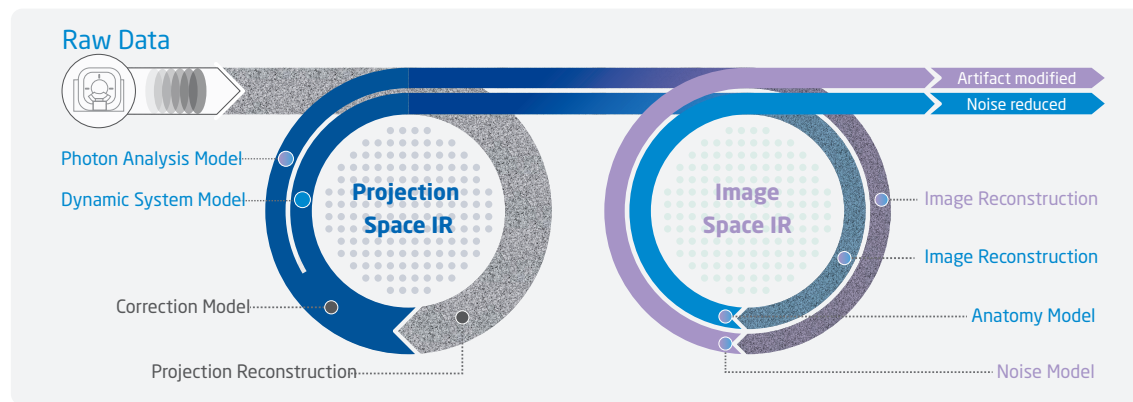

NeuViz ACE (SP) exclusively offers 60 kV scanning, an industry first, for better patient care. Compared to 120 kV, 60 kV provides over 94% dose reduction with diagnostically unaffected image quality, maximizing protection for dose-sensitivity, especially pediatric patients.

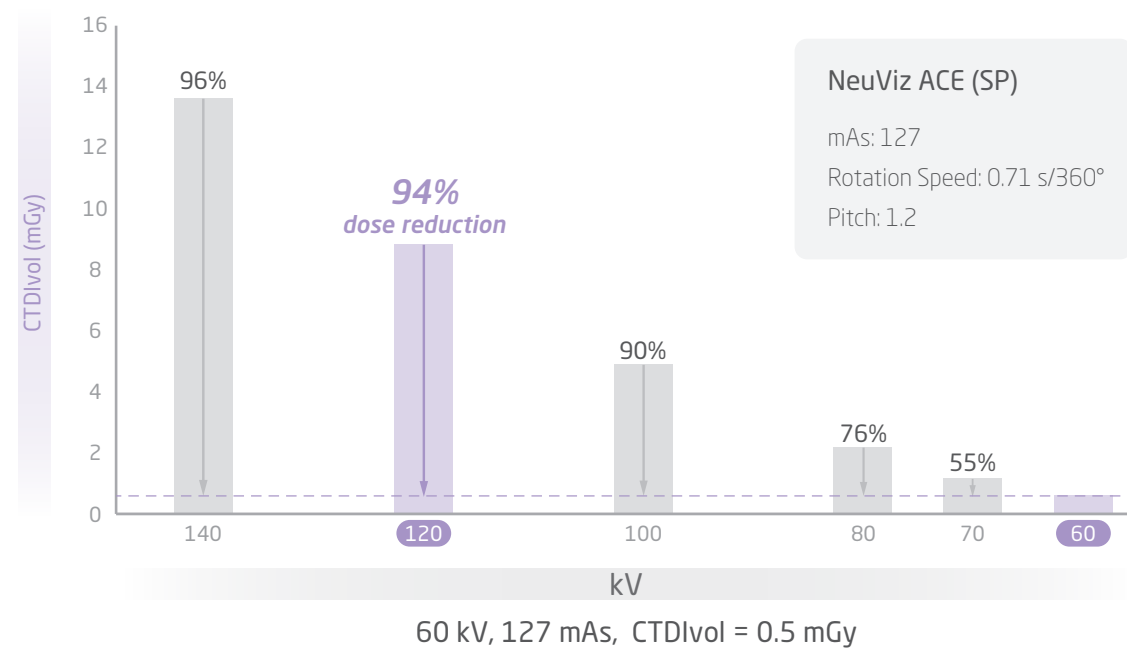

Female, Age: 7, Weight: 23 kg, BMI:15.7
 Leukemia for many years, intermittent fever for a month and cough for 2 days, pulmonary fungal infections.
 60 kV, 165 mA, CTDIvol: 0.4 mGy, DLP: 8 mGy*cm, Effective dose: 0.1 mSv

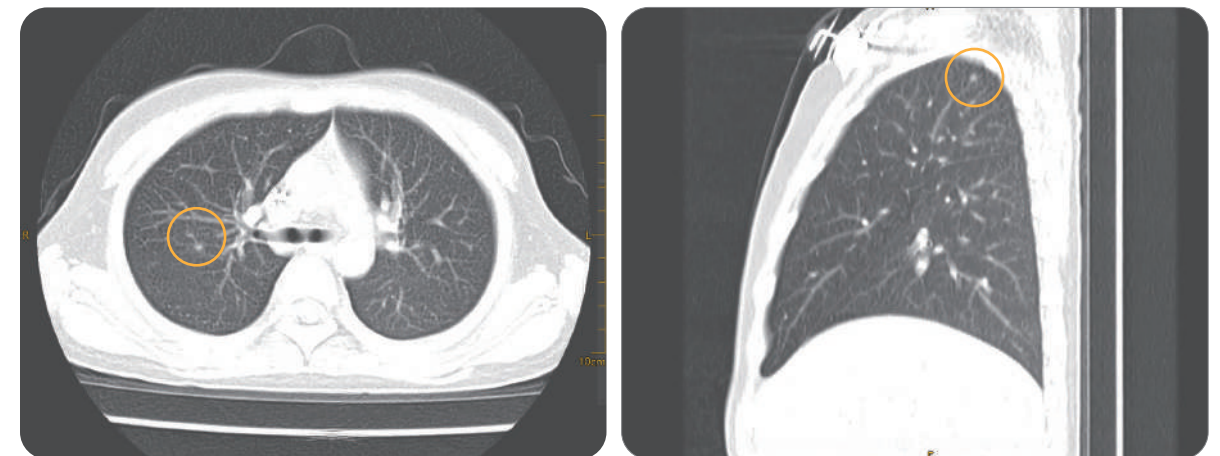

Female, Age: 82, Weight: 60 kg, BMI:22
 60 kV, Exposure time: 15.28 s, CTDIvol: 1.0 mGy, DLP: 29.3 mGy*cm, Effective dose: 0.41 mSv

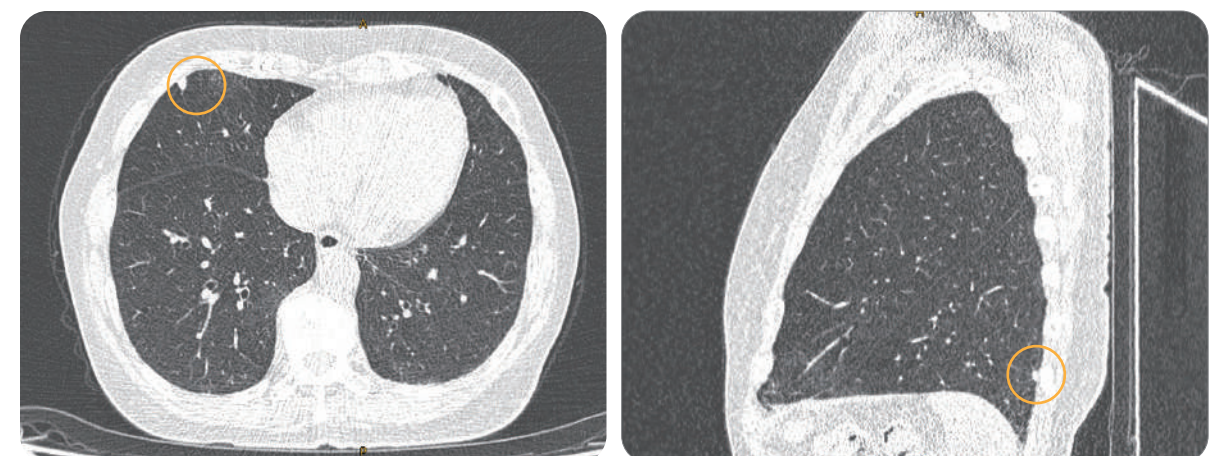

Inspire your clinical value

Lower kV CT Angiography

Lower kV presents a diagnostic advantage in CT Angiography by decreasing radiation dose and contrast material volume, which is particularly beneficial for renally impaired patients, minimizing the need for time-consuming and high-cost after-care procedures (e.g., monitoring and renal function tests).

100 kV Large Range CTA

Stent surgery follow up exam, severe stenosis of celiac trunk.

CTDIvol: 7.5 mGy , DLP: 542.7 mGy*cm, Effective dose: 8.14 mSv; Scan length: 701 mm



100 kV Abdomen CTA

Reexamination after aortic dissection stenting.

CTDIvol: 7.5 mGy, DLP: 536 mGy*cm, Effective dose: 8.04 mSv; Scan length: 692 mm



80 kV Carotid CTA

Right vertebral artery narrow.

CTDIvol: 6.4 mGy, DLP: 241.1 mGy*cm, Effective dose: 0.75 mSv

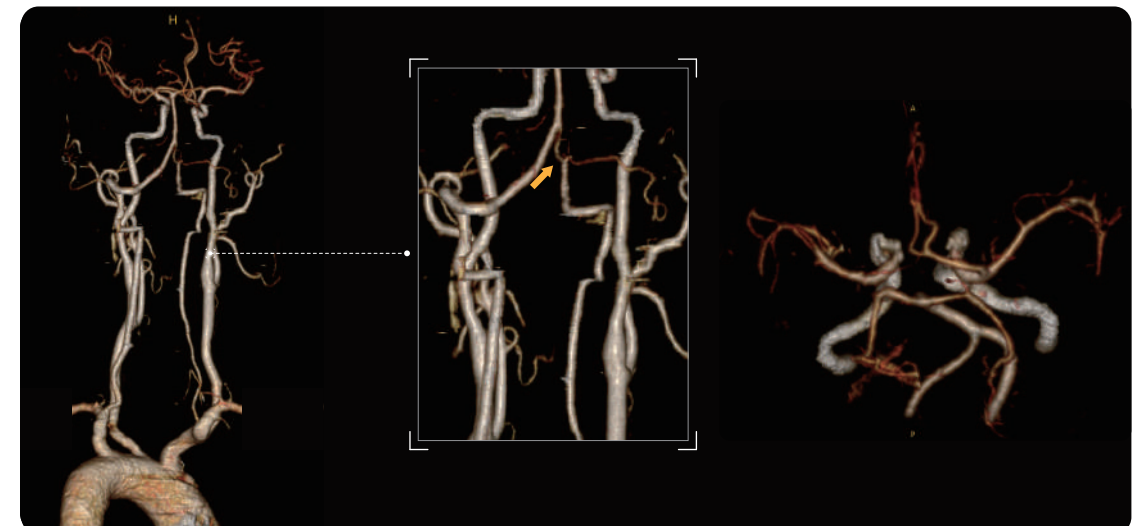

Inspire your clinical value

HD Imaging Chain

Market-leading high definition imaging solutions and innovations are brought together in NeuViz ACE (SP), delivering clear visualization of subtle structures, early detection of micro-lesions and exceptional clinical outcomes.



120 kV, 168 mA, 1024 Matrix, CTDIvol: 15.1 mGy, DLP: 273.5 mGy*cm, Effective dose: 4.1 mSv

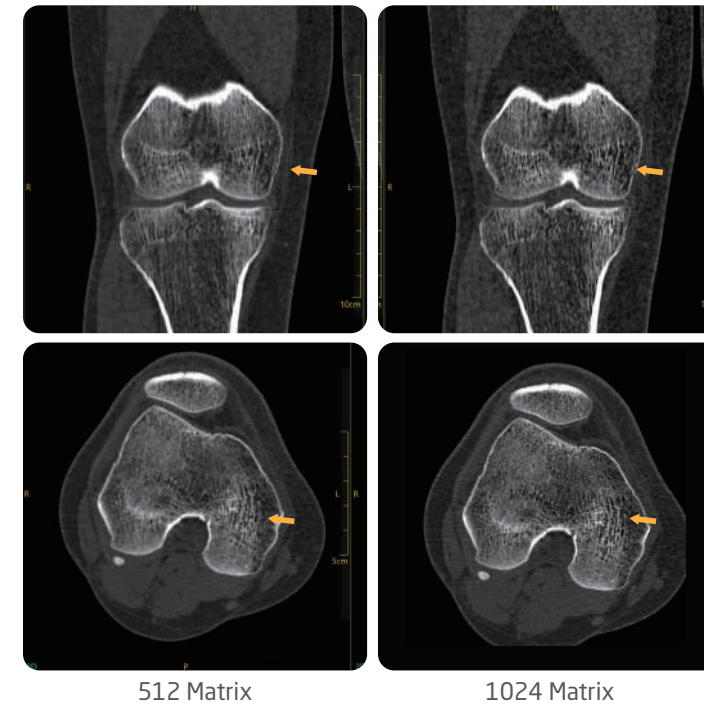

100 kV, 254 mA, 1024 Matrix, CTDIvol: 7.4 mGy, DLP: 282.6 mGy*cm, Effective dose: 3.9 mSv

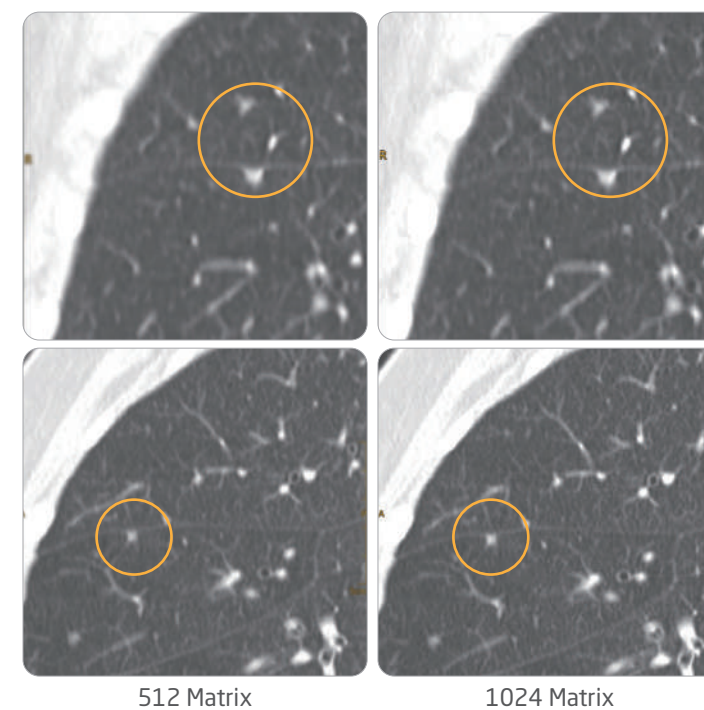

Inspire your clinical value

Excellent Clinical Routine

NMS (Neusoft Medical Systems) is continuously innovating state-of-the-art Reconstruction Algorithms for image clarity.

For neuro imaging, NeuViz ACE (SP) delivers the speed and accuracy, enabling fast life-saving intervention decisions with detailed display of brain structures.

Postoperative reexamination of cerebral hemorrhage

CTDIvol: 48.7 mGy, DLP: 685.8 mGy*cm, Effective dose: 1.44 mSv

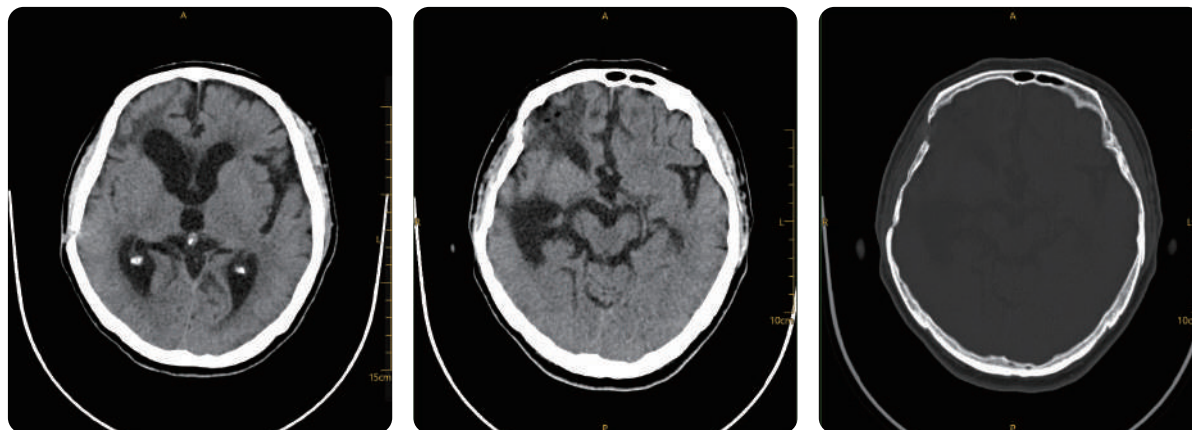

For lung imaging, low-dose high definition acquisition enables CT lung cancer screening more accessible to high-risk, asymptomatic individuals.

Pulmonary bulla, Pleural effusion

CTDIvol: 5.8 mGy, DLP: 190.7 mGy*cm, Effective dose: 2.67 mSv



For abdominal imaging, NeuViz ACE (SP)'s balanced imaging chain offers defined edges and natural contouring for every clinical anatomy and lesions, essentially enhancing diagnostic confidence.

Hepatic cyst

120 kV, 240 mA, CTDIvol: 13.7 mGy, DLP: 418.2 mGy*cm, Effective dose: 6.27 mSv

100 kV, 240 mA, CTDIvol: 7.6 mGy, DLP: 232.2 mGy*cm, Effective dose: 3.48 mSv

120 kV, 240 mA, CTDIvol: 13.7 mGy, DLP: 418.2 mGy*cm, Effective dose: 6.27 mSv

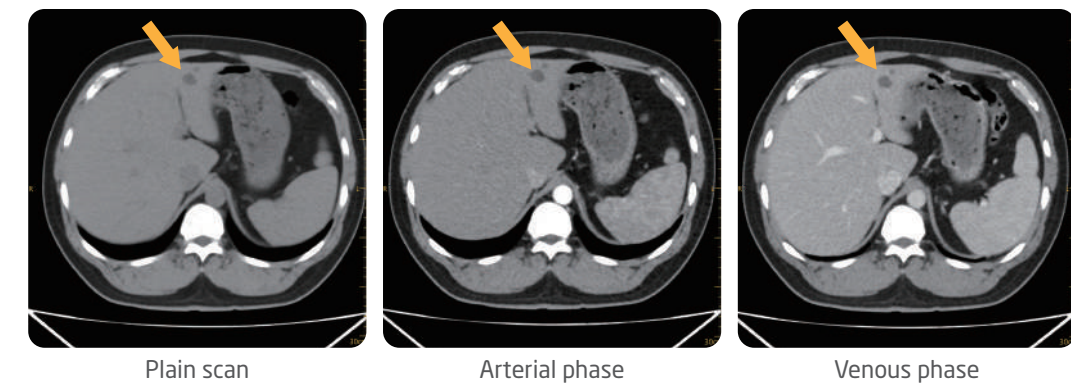

For orthopedic imaging, fast scan time, long scanning range, consistent image quality with a significant dose reduction benefit are the keys to reliable diagnostic outcomes for trauma patients who are potentially in a lot of pain and require immediate care.

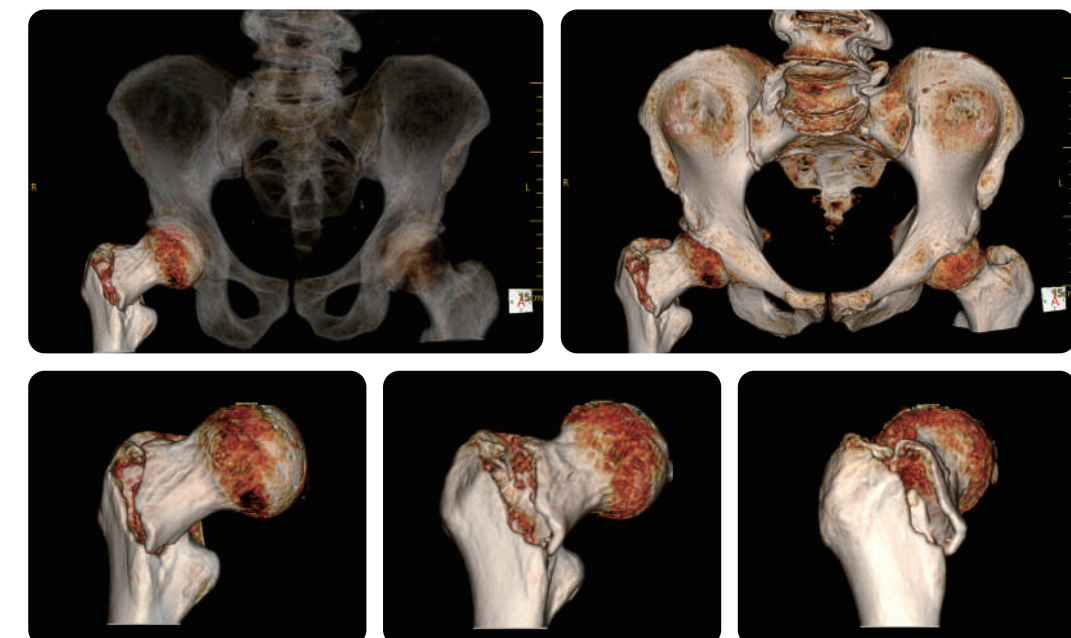

Inspire your clinical value

Reconstruct Max. 120-slice by Micro120

NeuViz ACE (SP) maximizes data collection and utilization, by leading-edge advancement Micro120 (accompanying with micro-STAR detector), NeuViz ACE (SP) can reconstruct up to 120 slices (min. 0.1 mm overlapping) for all scans independent of pitch. The increased slices in z-axis drastically suppresses spiral artifacts while vastly increases spatial resolution, thereby enabling to reveal micro lesions, tiny structures and contour delineation for outstanding clinical results.

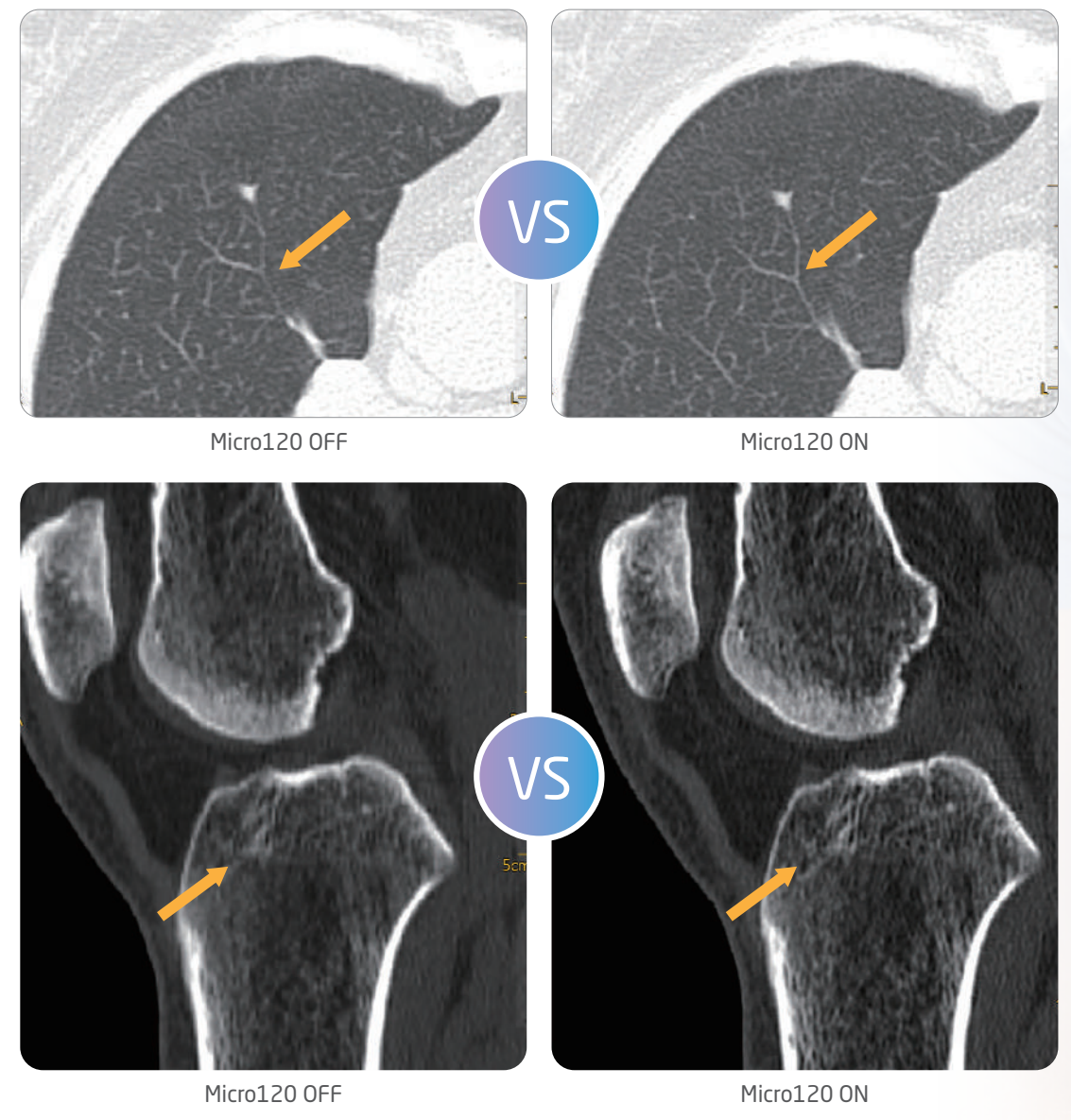

Inspire your clinical value

Spectral Imaging

With the assistance of Spectral Imaging, NeuViz ACE (SP) allows acquisition of both anatomical and functional information, providing better contrast images, metal artifact reduction, material separation and affirmation of eff-Z number, resulting in major gains in specificity and diagnostic accuracy.

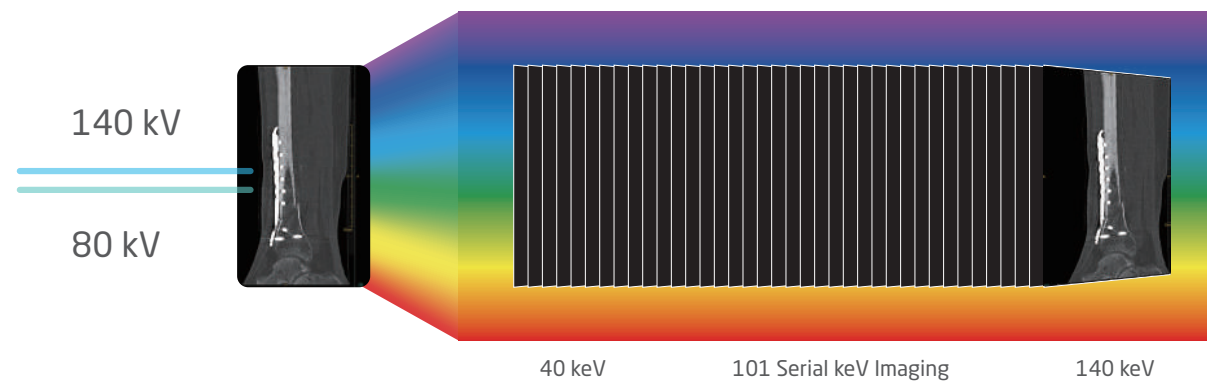

Gout Visualization

With an examination set up as simple as a regular spiral scan, Spectral Imaging adds valuable quantitative information to the morphology of conventional CT scans, providing material decomposition that can prove useful for gout visualization.

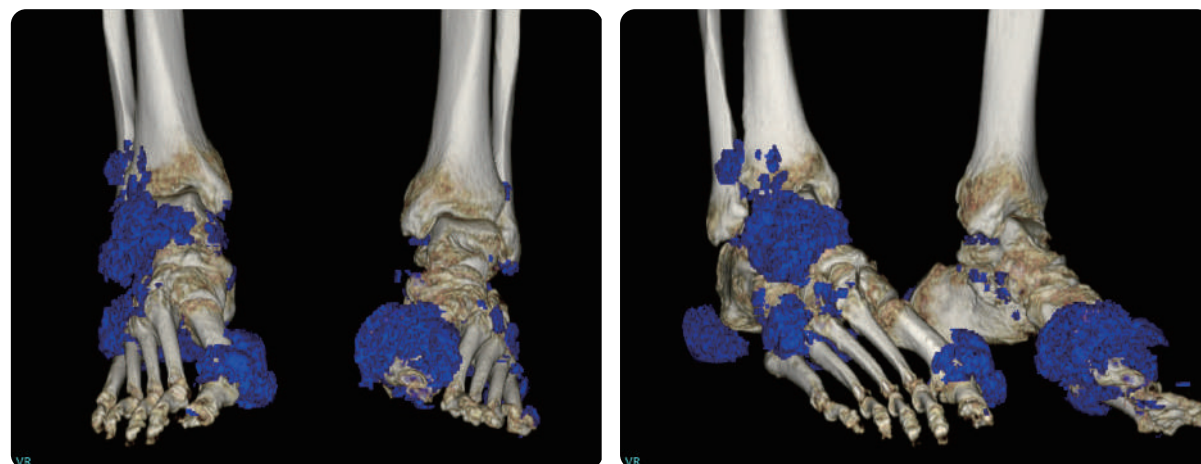

Metal Artifact Reduction

Imaging patients with metal implants has long been a challenge for all modalities. NeuViz ACE (SP) powered by Spectral Imaging can significantly reduce beam hardening artifacts through monochromatic energy synthesis, resulting in outstanding image quality with valuable diagnostic information.

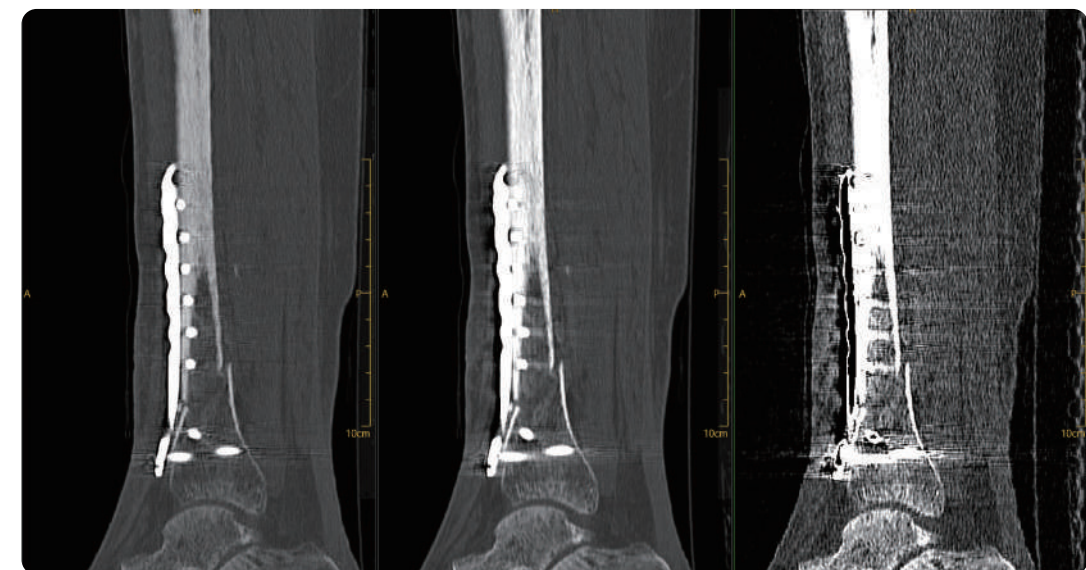

140 keV

70 keV

40 keV



140 keV

70 keV

40 keV

Inspire your workflow-value

Efficient Daily Work

Streamlined workflow and intuitive design from set up to reporting standardize quality of care, maximizing throughput and optimizing resource utilization, easing scanning experiences for both clinicians and patients.

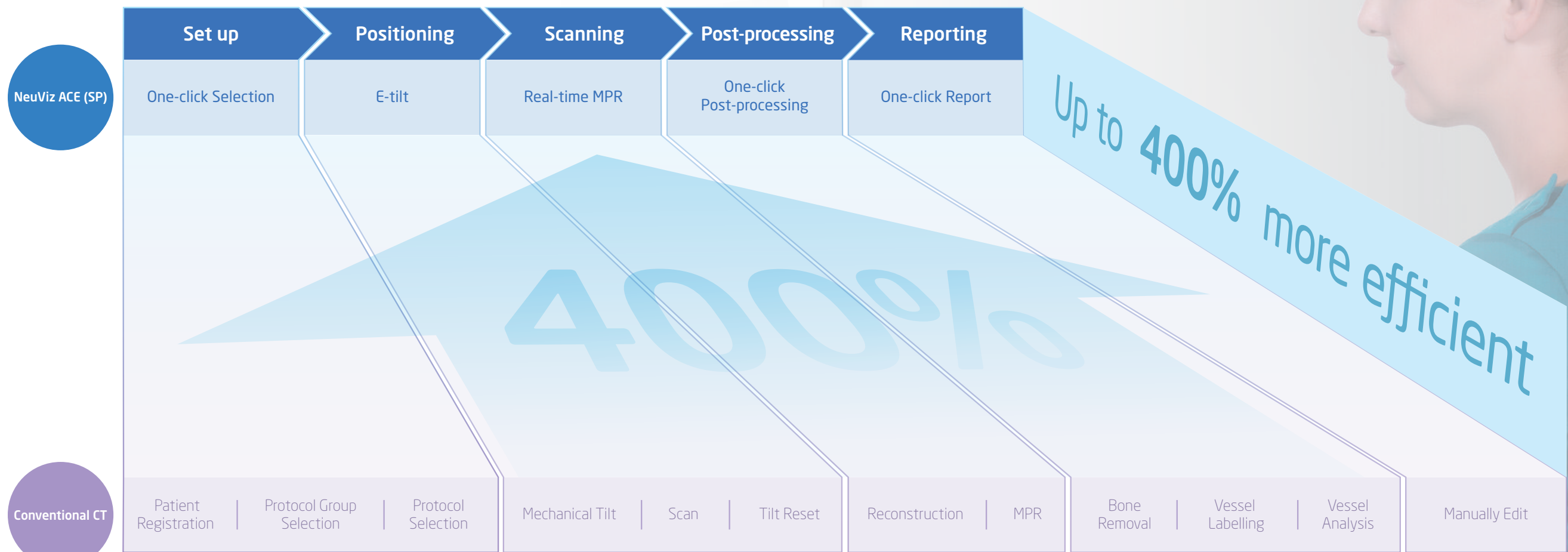

Inspire your workflow-value

Emergency Cases

In urgent cases, time is of the essence. The swift identification of life-threatening injuries and prompt initiation of appropriate care increases the chance of survival for patients. NeuViz ACE (SP)'s fast and reliable workflow with optimum-quality images for every patient proves vital for success in emergency medicine. One click. Zero wait. Saves time, saves lives.



Emergency Mode can bypass administrative steps in critical situations.



When every second counts, operators should not have to worry about selecting protocols and setting scan parameters. NeuViz ACE (SP) makes scan set up easier and effortless by automatically grouping together favorite or frequently used protocols with an interactive user-friendly graphical interface. Smart protocol management provides up to 10 preset protocols dedicated to emergency imaging. One-click selection. One-click scanning.



E-tilt streamlines scanning procedure by digitalizing mechanical tilt up to 30 degrees. Simpler and faster, this advancement helps technicians efficiently manage challenging and less cooperative patients, while completing the scan with the quality needed.



Real-time MPR displays multi-planar reconstructed images during scanning allowing you to monitor the results simultaneously – a productive tool to mitigate rescans and time loss.



NeuViz ACE (SP)'s sophisticated clinical application software packages makes time consuming and complex post-processing procedures easier, more intuitive and faster. One-click bone removal, automatic vessels labelling and one-click analysis not only saves time but also create robust and reproducible results. In just a few seconds, high-quality images are available for diagnoses.



One-click Report saves and sends the analysis result to customized or preset templates relieving the workload burden for reporting radiologists.



Inspire your economic value

Energy Saving Design

NeuViz ACE (SP) utilizes intelligent power management design to optimize power consumption during scanning and reduces stand-by power consumption, in combination with effective electricity transmission system, resulting in 12% power usage reduction. Decreased energy requirements lowers operational costs while minimizing the environmental footprint contributing to a greener planet.

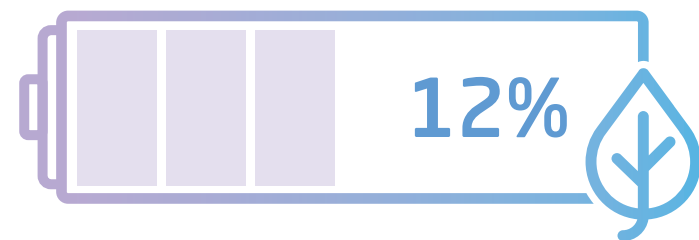

Time Saving Design

NeuViz ACE (SP) incorporates the up-to-date hardware, software and reconstruction technologies to provide excellent operability maximizing productivity. Thanks to its rotation time of 0.71 s, and an efficient workflow with simplified processes and one-click readiness, NeuViz ACE (SP) reduces door-to-report time up to 75% without compromising accuracy compared to a conventional CT, leading to faster and trusted clinical results, giving you more valuable time to take better care of your patients.

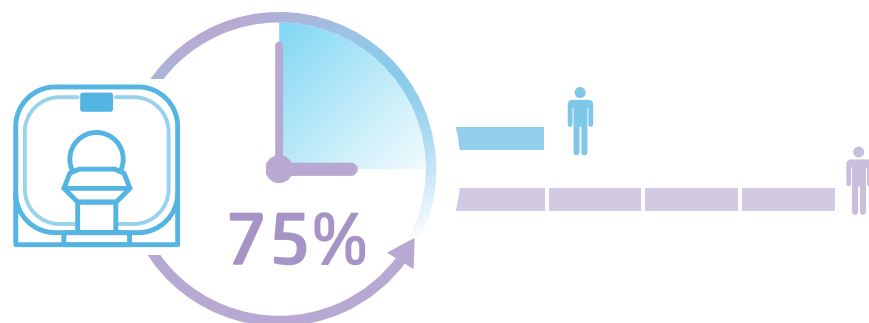

Room Saving Design

Capitalizing on the engineered geometry space design. A compact installation space lowers your footprint of minimum 11.8 m², 42% smaller than previous NeuViz model investment but also means more space for work, more space for other equipment and more beds to expand your capacity for future demands.

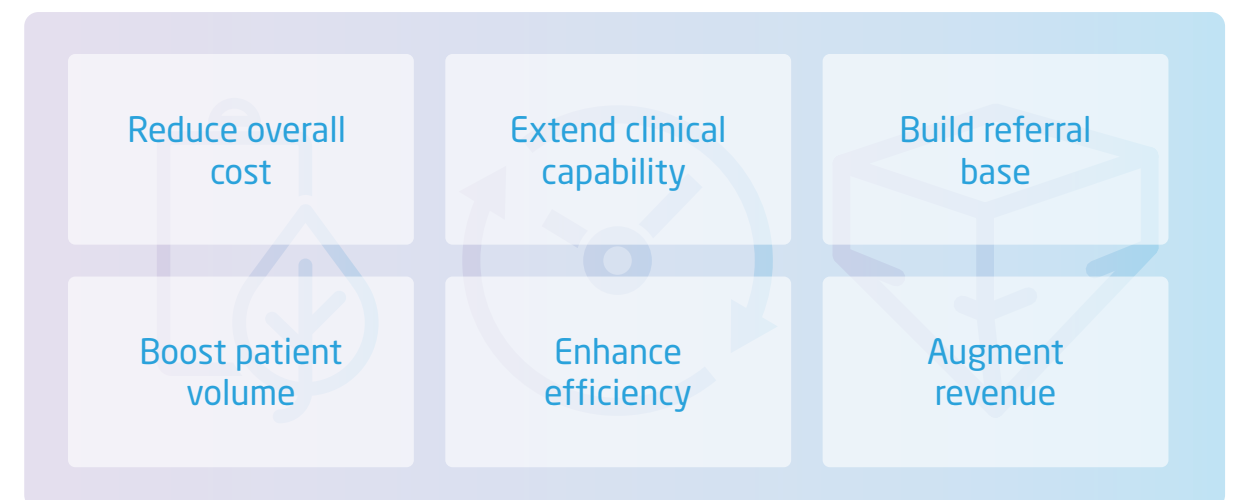
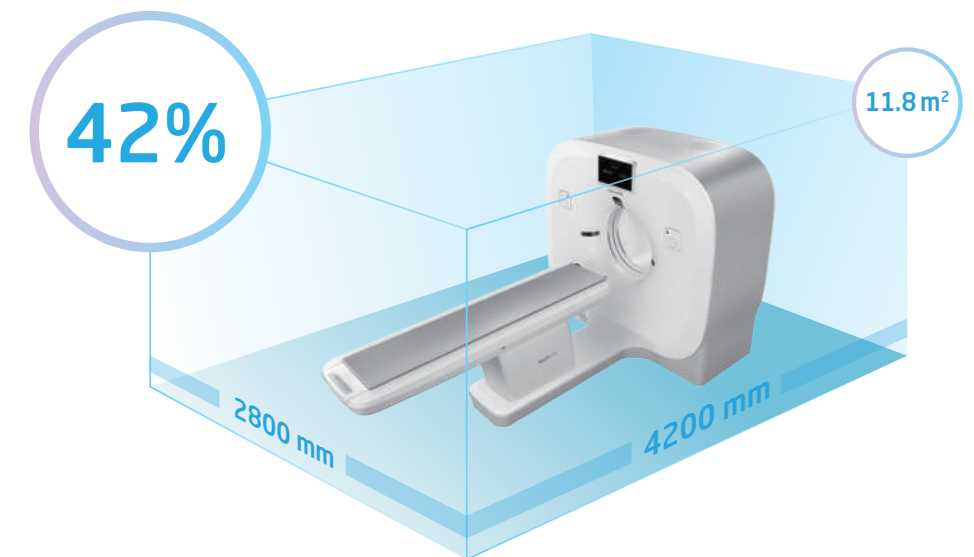

Technical Specifications

Key data:

Tube heat capacity.....3.5 MHU
Generator power.....32 kW
kV steps.....60, 70, 80, 100, 120, 140 kV
mA range.....10-320 mA
Slices.....16/32 slices
Rotation time.....0.71 s/360°
Spatial resolution.....15 lp/cm @ 0% MTF
Low contrast resolution.....2 mm @ 0.3%

CARE60

250 mm FOV

Micro-STAR Detector

0.7 x 0.8 mm focal spot

0.5 mm collimation

Spectral Imaging

ER mode

1024 matrix imaging

Compact design

Micro120

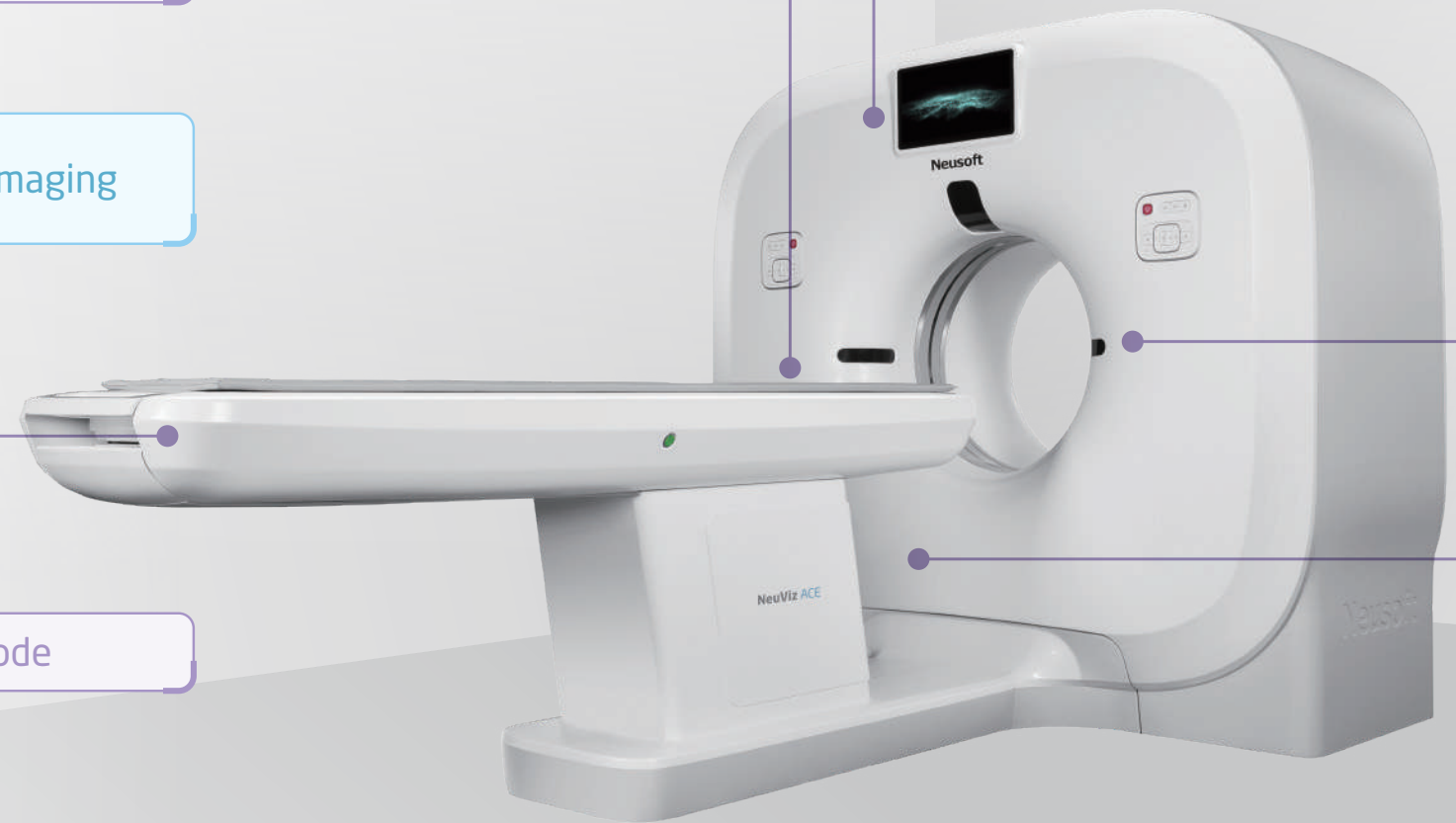

Service and Logistics Support



Neusoft Global Service & Logistics Network

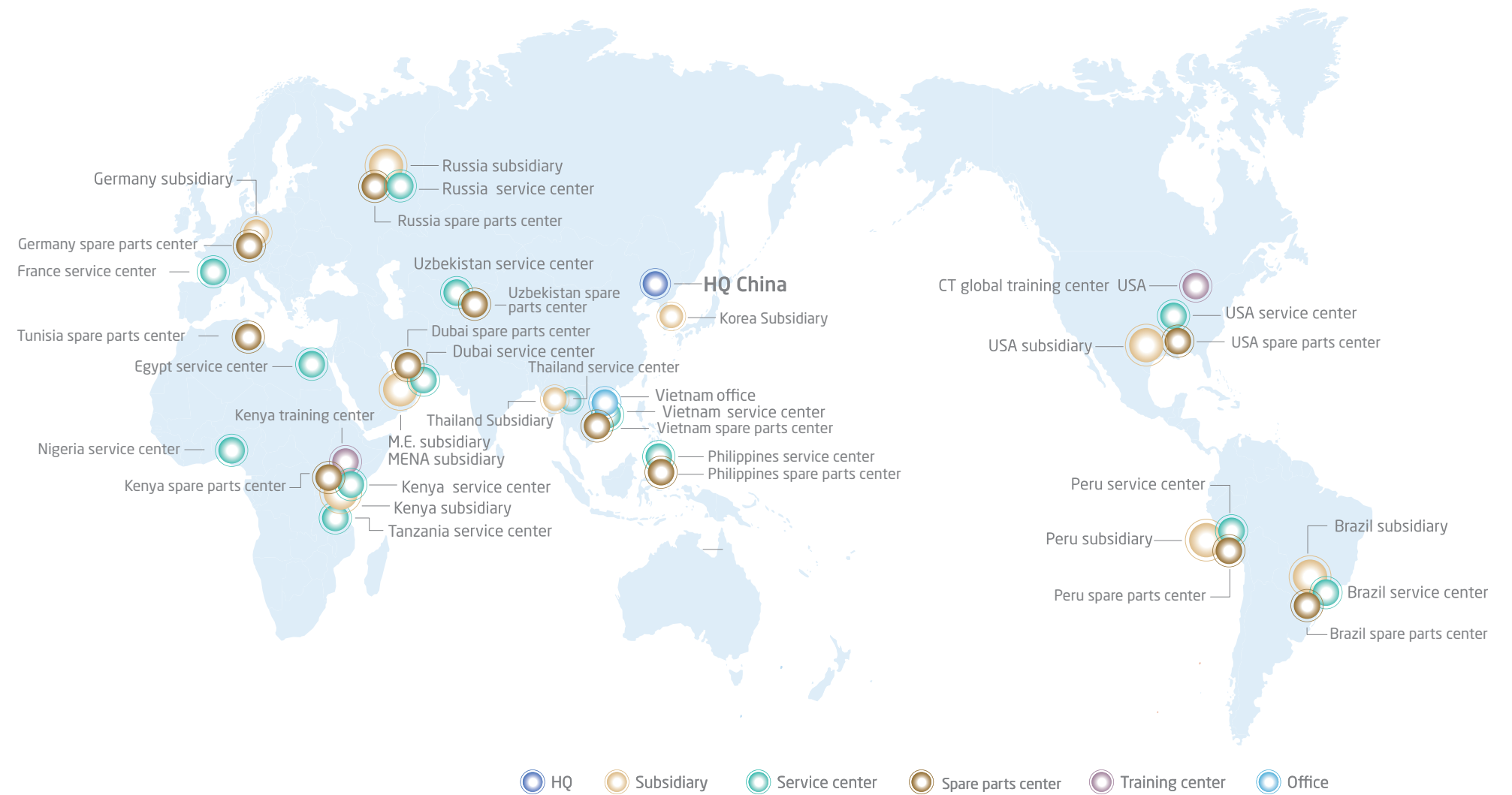

After-sales service and support

- Remote service capabilities bring Neusoft expertise to you IMMEDIATELY, no matter where you are!
- Identifying and correcting PROMPTLY and PROACTIVELY, minimizing downtime and patient inconvenience.
- Global logistics network enables fast response regarding parts and supplies.

* Note: The contents of this publication and the listed parameters are for reference only and not intended as legal offers or commitments. Neusoft Medical Systems reserves the right to modify the contents, design, specifications and options described herein without prior notice, and will not be liable for any consequences resulting from the use of this publication. Please contact your local Neusoft sales representative for the current information. The specific sales product configuration is subject to the actual contract signed by Neusoft.

* Not available in the United States.